

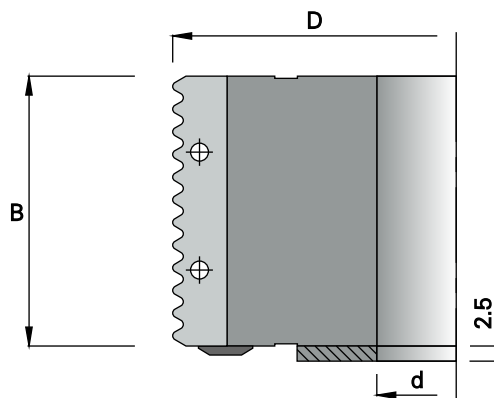

K 428 - A

Testa per giunzioni



HW

MAN

n 6200 - 10700

D	B	d	Z	COD.
125	60	30	2	K428A00030
125	60	31.75	2	K428A00031
125	60	35	2	K428A00035
125	60	40	2	K428A00040
125	60	50	2	K428A00050

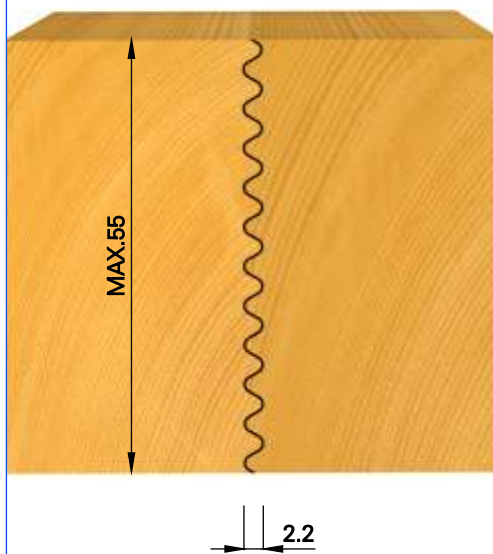

Ricambi / Spare parts / Rechanges / Repuestos / Ersatzteile

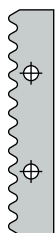

60x12x1.5

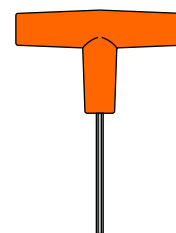

COD.
K48028A000

COD.
0480505628

COD.
048060C000

COD.
0480700612

COD.
048073B000

COD.
0480783000

Glue jointing cutter head.

Porte - outil pour abouter.

Cabezal para ensamble.

Verleim - Messerkopf.

K 428 - A 80

Testa per giunzioni

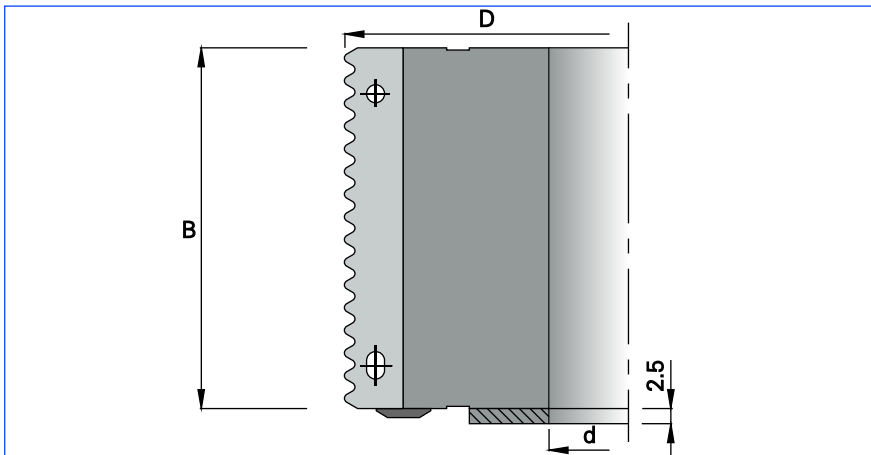

HW

MAN

n 6200 - 10700

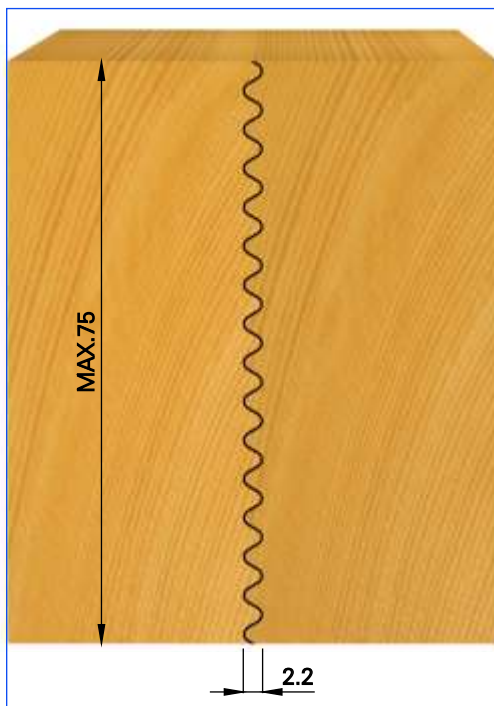

D	B	d	Z	COD.
125	80	30	2	K428A08030
125	80	31.75	2	K428A08031
125	80	35	2	K428A08035
125	80	40	2	K428A08040
125	80	50	2	K428A08050

Ricambi / Spare parts / Rechanges / Repuestos / Ersatzteile



80x13x2.2

COD.

K48028A080

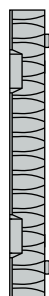

COD.

0480507628



COD.

048060C000



COD.

0480700612



COD.

048073B000

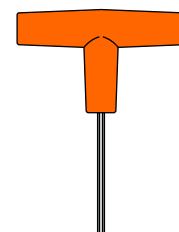

COD.

0480783000



Glue jointing cutter head.



Cabezal para ensamble.



Porte - outil pour abouter.



Verleim - Messerkopf.



428 - B

Testa per giunzioni

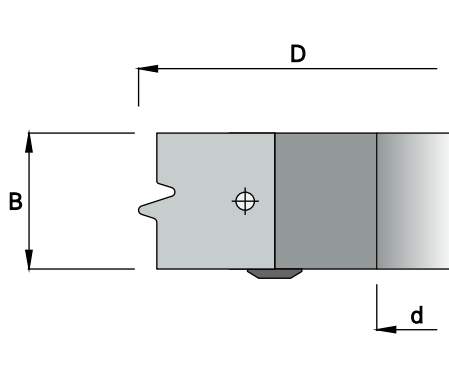

HW

MEC

n max 7000

D	B	d	Z	COD.
140	30	30	3	0428B00030
140	30	35	3	0428B00035
140	30	40	3	0428B00040
140	30	50	3	0428B00050

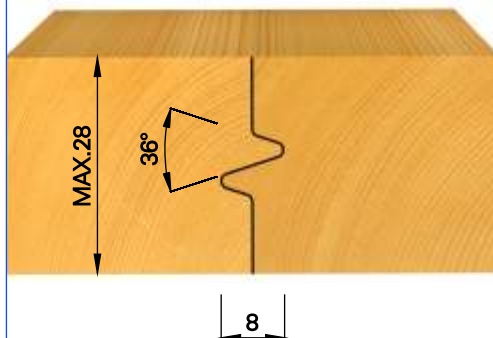

Ricambi / Spare parts / Rechanges / Repuestos / Ersatzteile

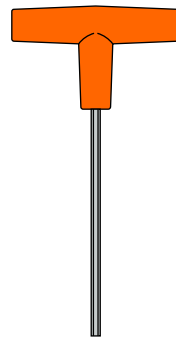

Inserto

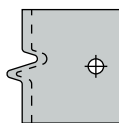

30x30x3

Supporto

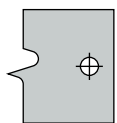

30x26.5x5

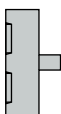

COD.
048028B003

COD.
048028B001

COD.
04805128F0

COD.
0480701020

COD.
048073B000

COD.
048078L500

Glue jointing cutter head.

Cabezal para ensamble.

Porte - outil pour abouter.

Verleim - Messerkopf.

428 - C

Testa per giunzioni

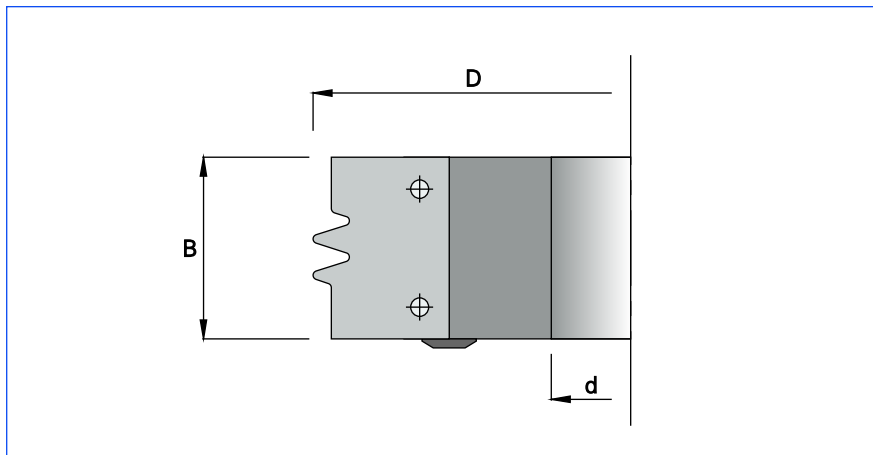

HW **MEC**

n max 7000

D	B	d	Z	COD.
140	40	30	3	0428C00030
140	40	35	3	0428C00035
140	40	40	3	0428C00040
140	40	50	3	0428C00050

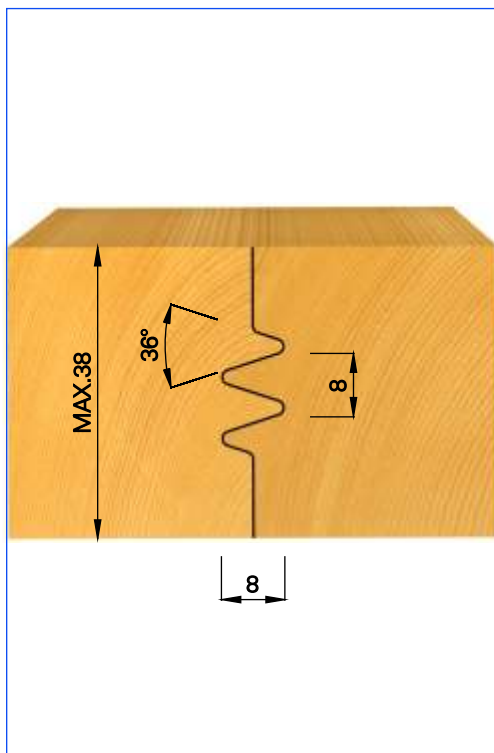

Ricambi / Spare parts / Rechanges / Repuestos / Ersatzteile

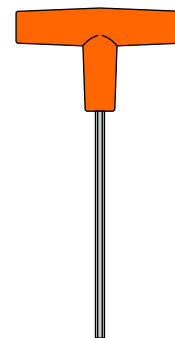

Inserto

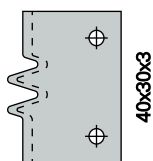

40x30x3

COD.

048028C003

Supporto

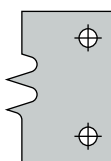

40x26.5x5

COD.

048028C001

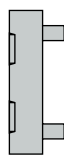

COD.

04805138F0



COD.

0480701020



COD.

048073B000

COD.

048078L500



Glue jointing cutter head.



Cabezal para ensamble.



Porte - outil pour abouter.



Verleim - Messerkopf.



428 - D

Testa per giunzioni

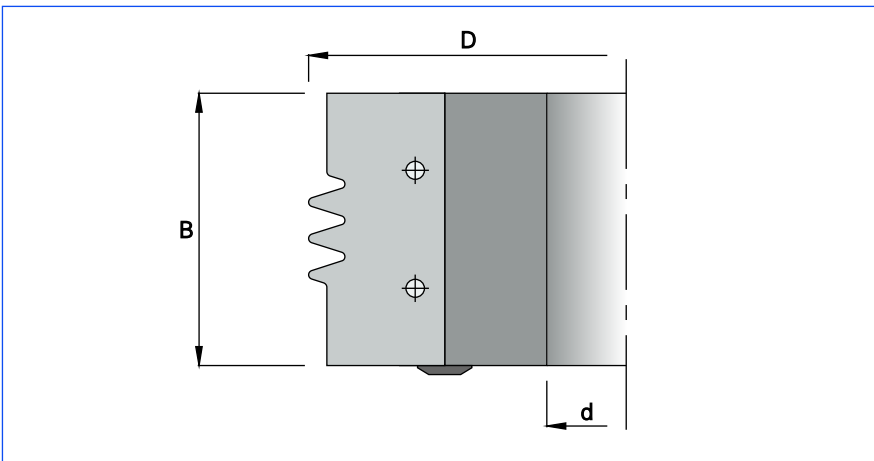



HW **MEC**

n max 7000

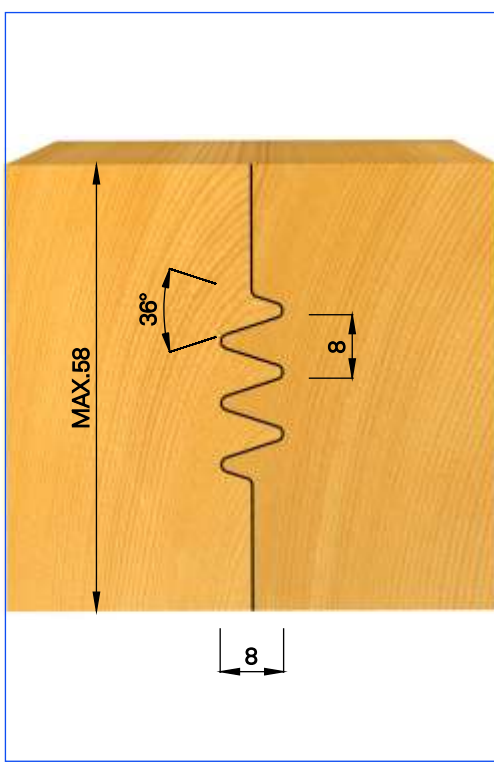
D	B	d	Z	COD.
140	60	30	3	0428D00030
140	60	35	3	0428D00035
140	60	40	3	0428D00040
140	60	50	3	0428D00050

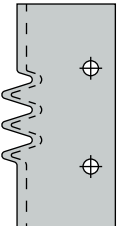
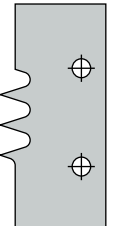
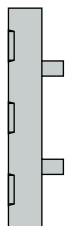

Ricambi / Spare parts / Rechanges / Repuestos / Ersatzteile

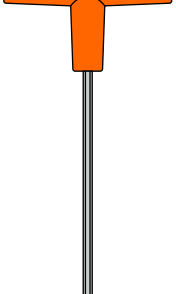
 Inserto COD. 048028D003	 Supporto COD. 048028D001	 COD. 04805158F0	 COD. 0480701020	 COD. 048073B000	 COD. 048078L500
--	---	---	---	---	---

- | | |
|--|--|
|  Glue jointing cutter head. |  Cabezal para ensamble. |
|  Porte - outil pour abouter. |  Verleim - Messerkopf. |

K 428 - E

Testa per giunzioni

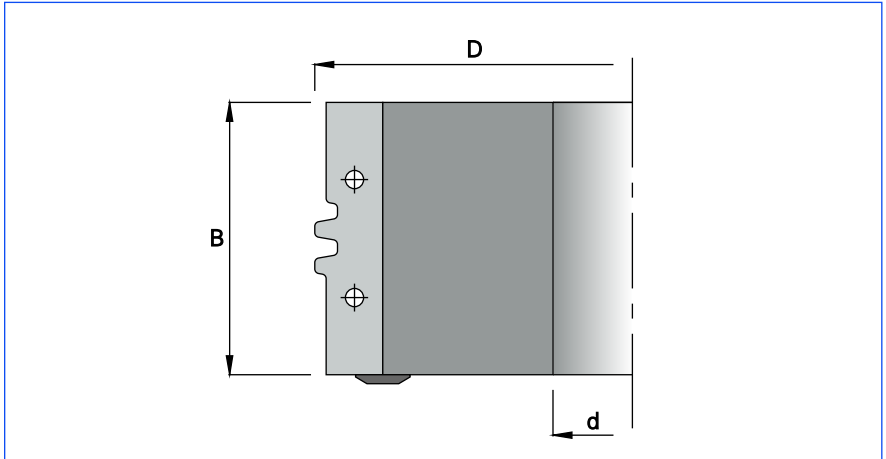

HW **MAN**

n 5500 - 9500

D	B	d	Z	COD.
140	60	30	2	K428E00030
140	60	35	2	K428E00035
140	60	40	2	K428E00040
140	60	50	2	K428E00050

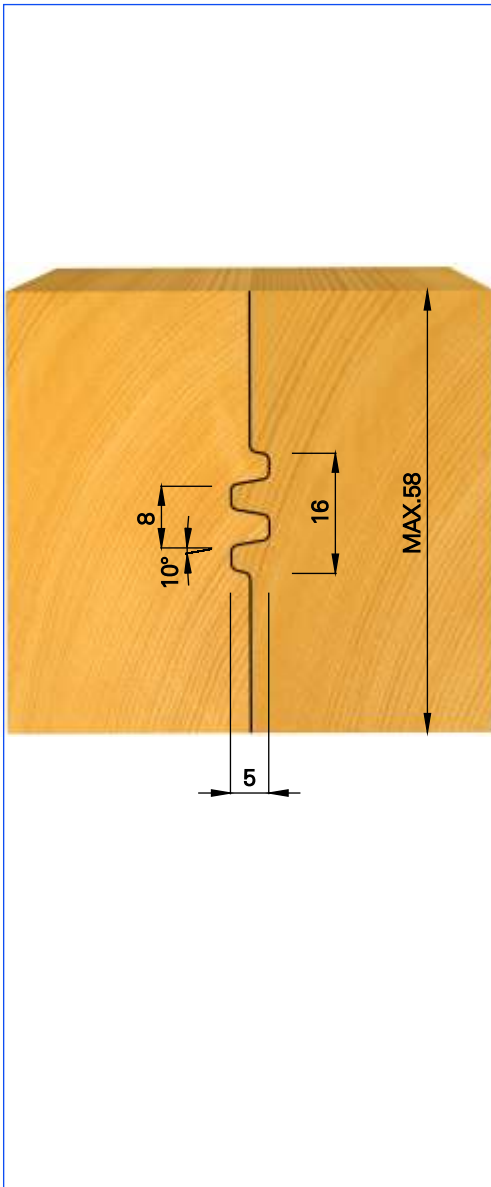

Ricambi / Spare parts / Rechanges / Repuestos / Ersatzteile

COD.	COD.	COD.	COD.
K48028E000	048050AET0	048060C000	0480700612
COD.	COD.		
048073B000	0480783000		

Glue jointing cutter head.

Cabezal para ensamble.

Porte - outil pour abouter.

Verleim - Messerkopf.



K 428 - F

Testa per giunzioni

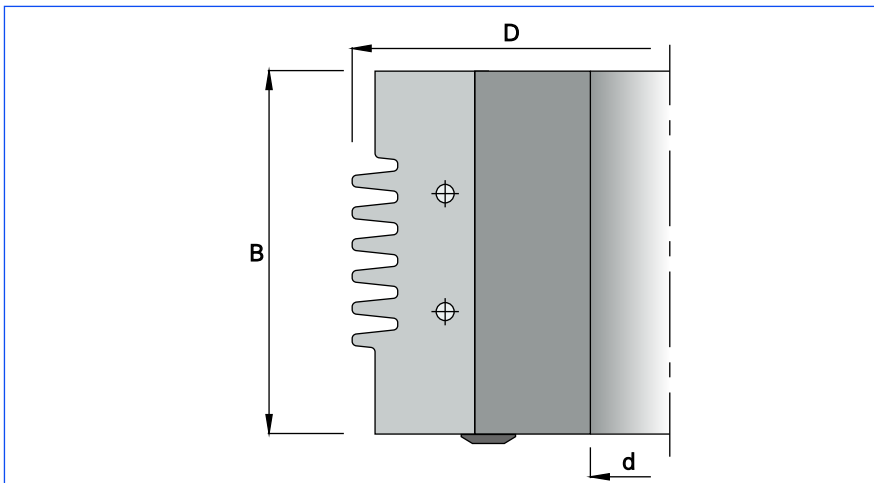

HW



MAN

n 5500 - 9500

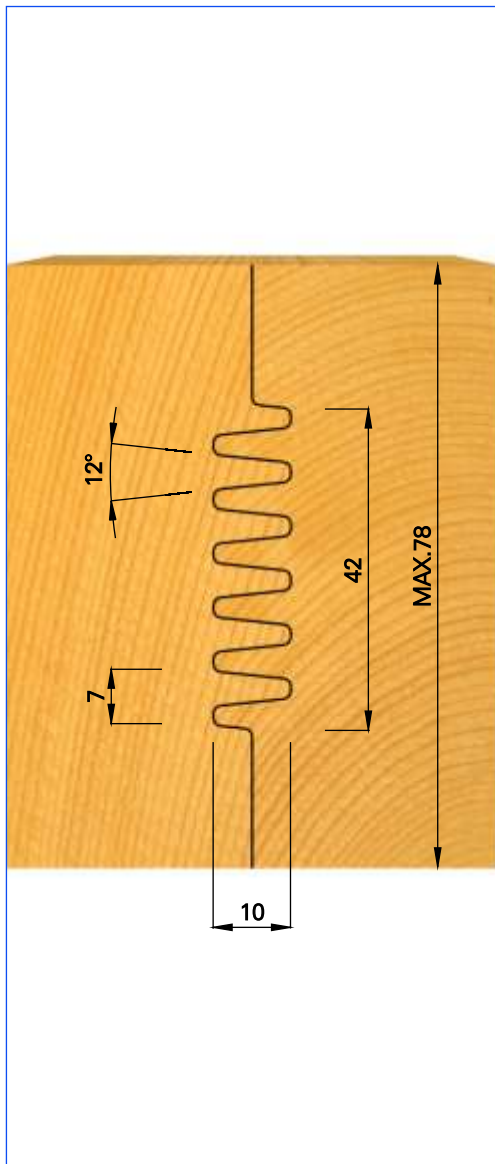
D	B	d	Z	COD.
140	80	30	3	K428F00030
140	80	35	3	K428F00035
140	80	40	3	K428F00040
140	80	50	3	K428F00050

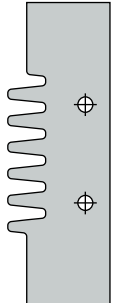
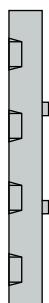

Ricambi / Spare parts / Rechanges / Repuestos / Ersatzteile

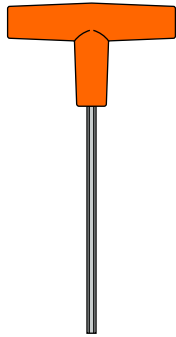
		
80x27x3		
COD.	COD.	COD.
K48028F000	0480527825	0480700820
		
COD.	COD.	
048073B000	048078L400	

 Glue jointing cutter head.

 Cabezal para ensamble.

 Porte - outil pour abouter.

 Verleim - Messerkopf.

K 428 - G Teste per giunzioni regolabili con anelli

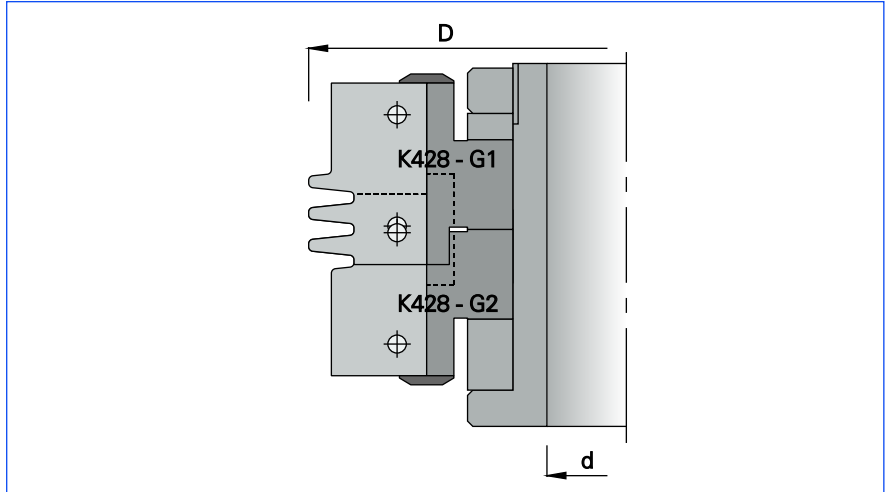

HW





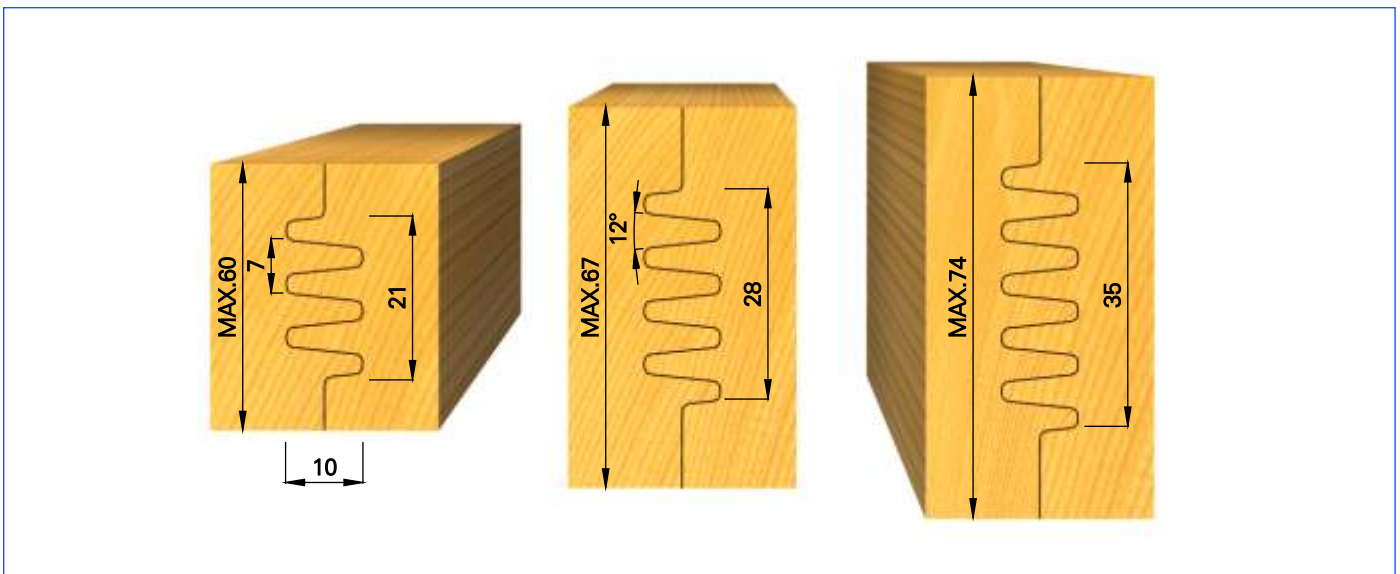

MAN

n 5100 - 8900

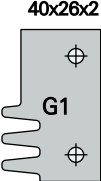
D	d	Z	COD.
150	30	2	K428G00030
150	31.75	2	K428G00031
150	35	2	K428G00035
150	40	2	K428G00040
150	50	2	K428G00050

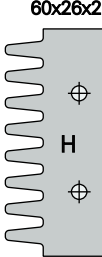

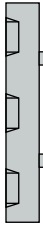
Ricambi / Spare parts / Rechanges / Repuestos / Ersatzteile

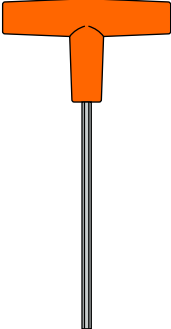
							
40x26x2	40x26x2	60x26x2					
G1	G2	H					
COD.	COD.	COD.	COD.	COD.	COD.	COD.	COD.
K48028G100	K48028G200	K48028H000	0480523825	0480525825	0480700820	048073B000	048078L400

 Adjustable glue jointing cutter heads.

 Cabezales para ensamble extensible.

 Porte - outils pour abouter extensibles.

 Verstellbar - Verleim - Messerköpfe.



K 428 - GH Teste per giunzioni regolabili con anelli

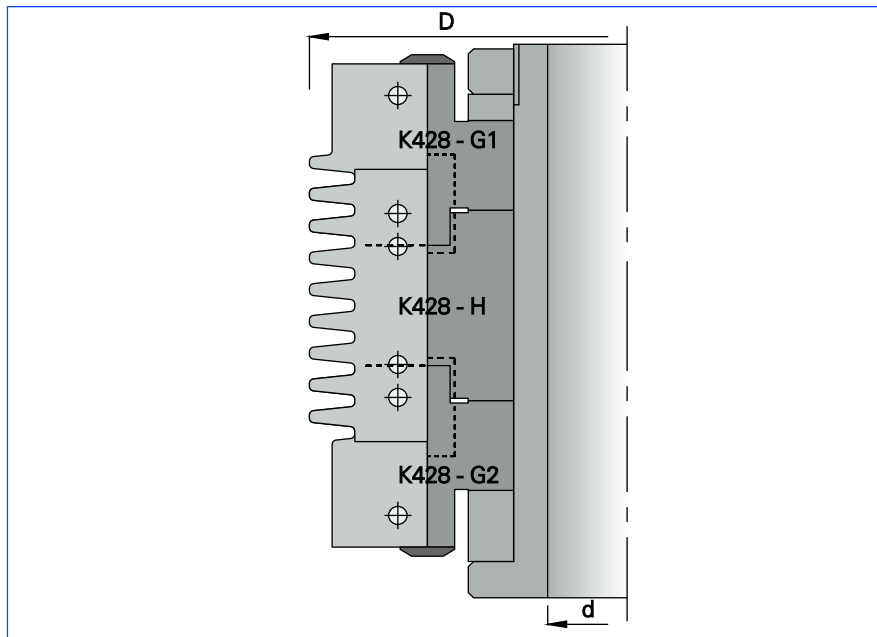

HW **MAN**

n 5100 - 8900

D	d	Z	COD.
150	30	2	K428GH0030
150	31.75	2	K428GH0031
150	35	2	K428GH0035
150	40	2	K428GH0040
150	50	2	K428GH0050

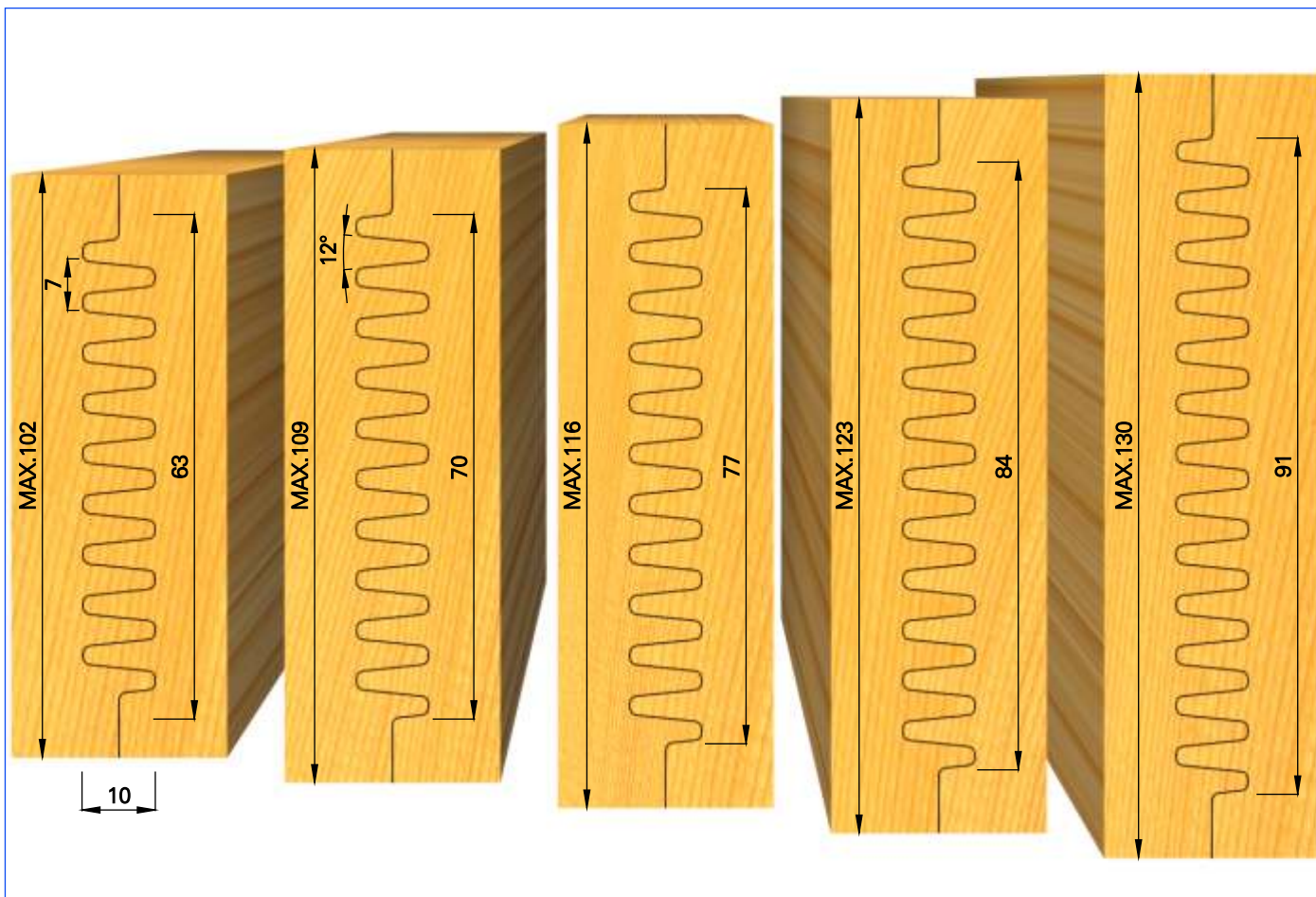

Adjustable glue jointing cutter heads.

Cabezales para ensamble extensible.

Porte - outils pour abouter extensibles.

Verstellbar - Verleim - Messerköpfe.

K 428 - R Teste per giunzioni regolabili con anelli

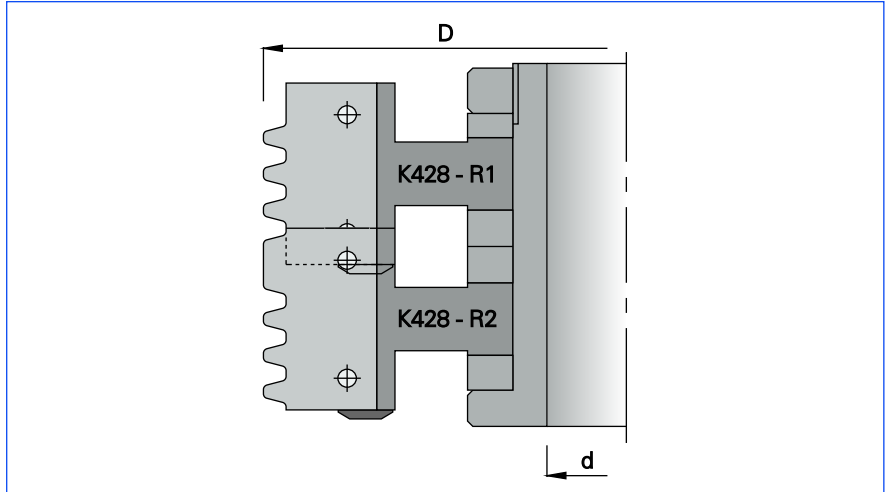

HW

MAN



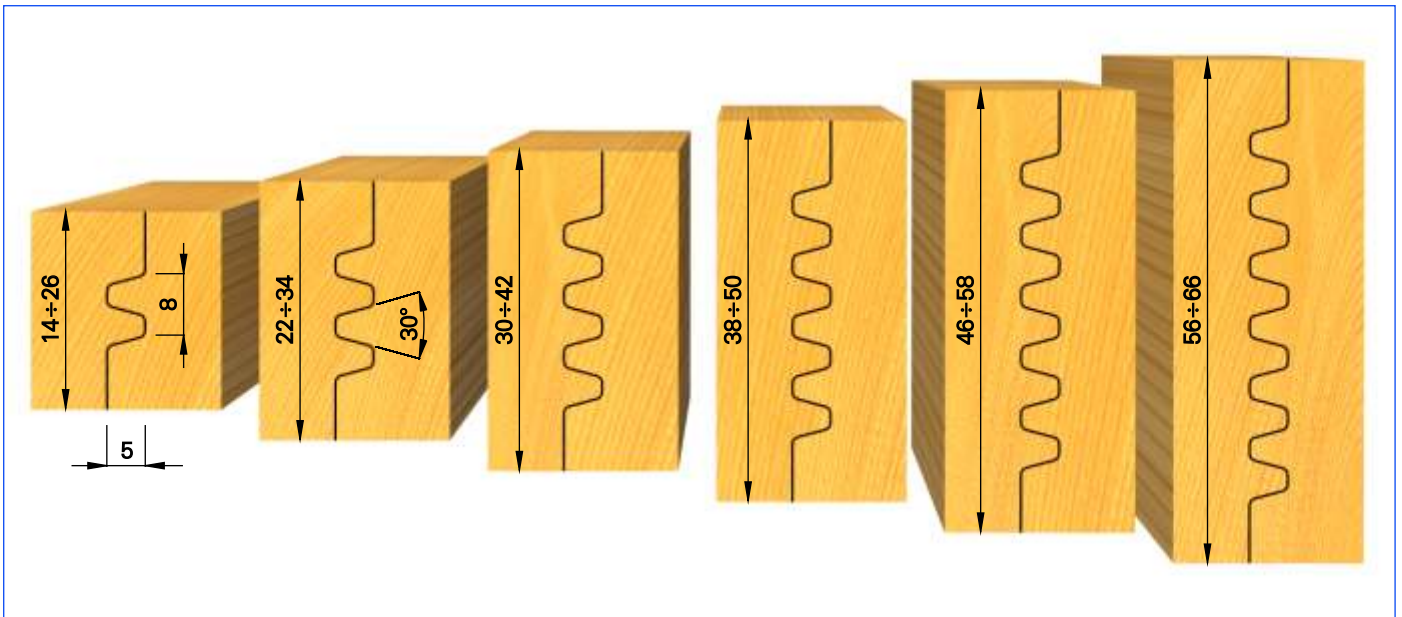

n 4800 - 8300

D	d	Z	COD.
160	30	2	K428R00030
160	31.75	2	K428R00031
160	35	2	K428R00035
160	40	2	K428R00040
160	50*	2	K428R00050

* Senza mozzo / Without sleeve / Sans manchon / Sin casquillo / Ohne Spannbuchse.

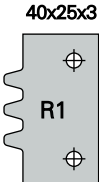
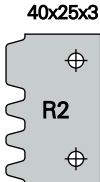

Ricambi / Spare parts / Rechanges / Repuestos / Ersatzteile

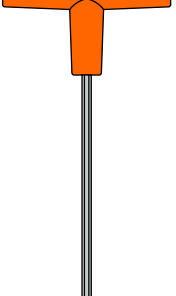
					
40x25x3	40x25x3				
R1	R2				
COD.	COD.	COD.	COD.	COD.	COD.
K48028R100	K48028R200	0480523825	0480700820	048073B000	048078L400

 Adjustable glue jointing cutter heads.

 Cabezales para ensamble extensible.

 Porte - outils pour abouter extensibles.

 Verstellbar - Verleim - Messerköpfe.



K 428 - T

Testa per giunzioni a 45°

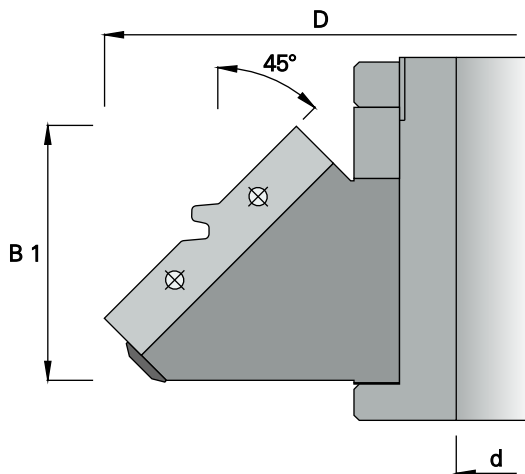

HW

MAN

n 4300 - 7400

D	B 1	d	Z	COD.
180	56	30	2	K428T00030
180	56	31.75	2	K428T00031
180	56	35	2	K428T00035
180	56	40	2	K428T00040
180	56	50*	2	K428T00050

* Senza mozzo / Without sleeve / Sans manchon / Sin casquillo / Ohne Spannbuchse.

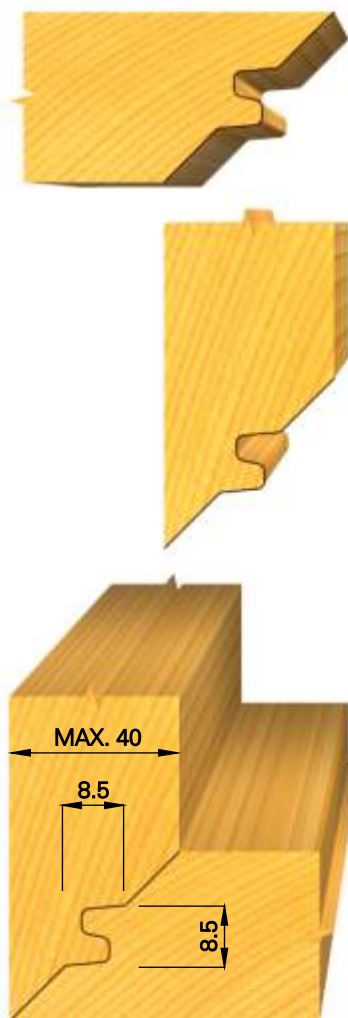

Ricambi / Spare parts / Rechanges / Repuestos / Ersatzteile

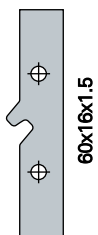

60x16x1.5

COD.

K48028T000



COD.

048050AET0



COD.

048060C000



COD.

0480700612



COD.

048073B000

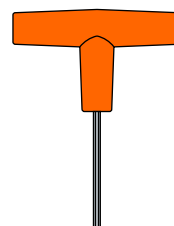

COD.

0480783000

45° Mitre glue jointing cutter head.

Cabezal para ensamble de inglete 45°.

Porte - outil pour bouvetage d' angle 45°.

Messerkopf zur Gehrungsverbindung 45°.

428 - Z

Gruppo di teste per giunzioni a 45°

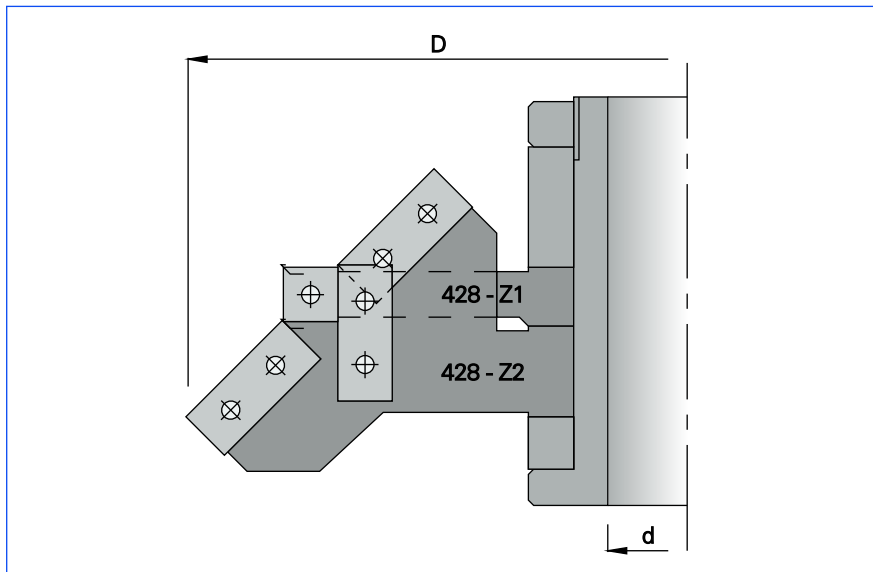

HW **MEC**

n max 6000

D	d	Z	V	COD.
220	30	4+2	2+2	0428Z00030
220	31.75	4+2	2+2	0428Z00031
220	35	4+2	2+2	0428Z00035
220	40	4+2	2+2	0428Z00040
220	50*	4+2	2+2	0428Z00050

* Senza mozzo / Without sleeve / Sans manchon / Sin casquillo / Ohne Spannbuchse.

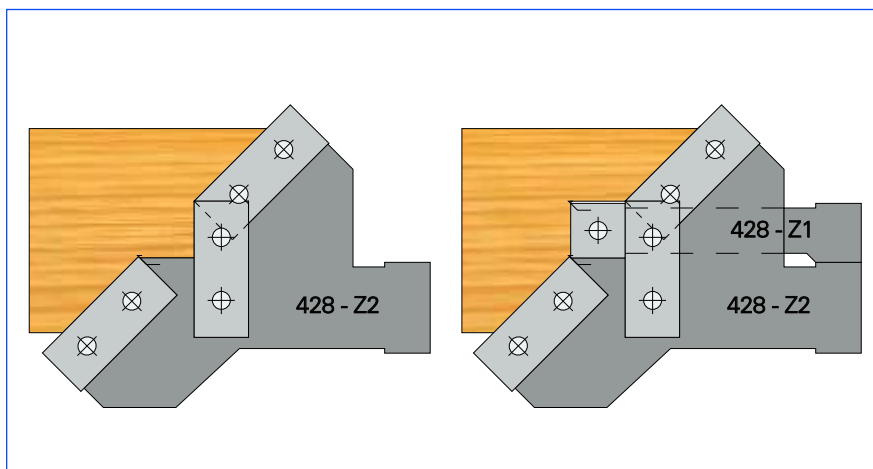
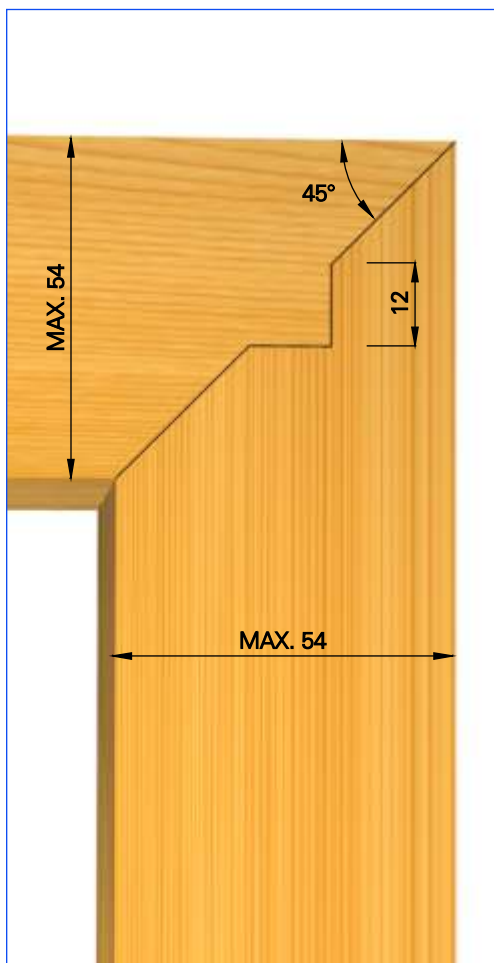

Ricambi / Spare parts / Rechanges / Repuestos / Ersatzteile

COD.	COD.	COD.	COD.	COD.	COD.	COD.	COD.	COD.	COD.	COD.
0480030014	0480050012	0480050030	0480501000							
COD.	COD.	COD.	COD.	COD.	COD.	COD.	COD.	COD.	COD.	COD.
0480502600	048060C000	0480700612	048074A510	0480783000	048078T200					

45° Mitre glue jointing cutter head set.

Juego de cabezales para ensamble de inglete 45°.

Jeu de porte - outil pour bouvetage d' angle 45°.

Messerkopfsatz zur Gehrungsverbinding 45°.



428 - ZH

Gruppo di teste per giunzioni a 45°

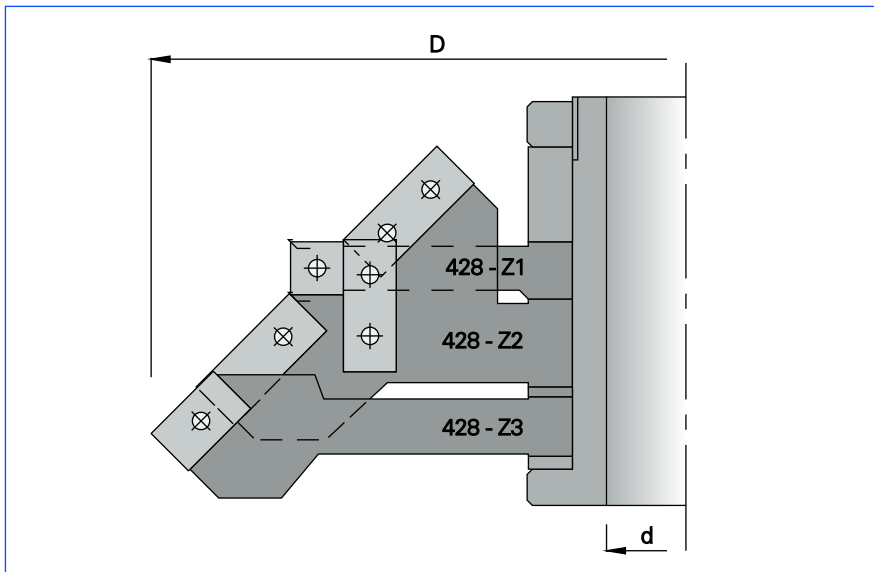

HW

MEC

n max 5400

D	d	Z	V	COD.
242	30	4+2	2+2	0428ZH0030
242	31.75	4+2	2+2	0428ZH0031
242	35	4+2	2+2	0428ZH0035
242	40	4+2	2+2	0428ZH0040
242	50*	4+2	2+2	0428ZH0050

* Senza mozzo / Without sleeve / Sans manchon / Sin casquillo / Ohne Spannbuchse.

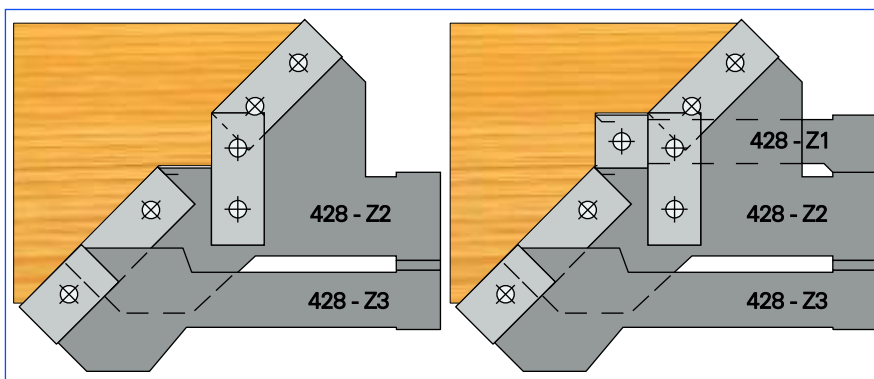
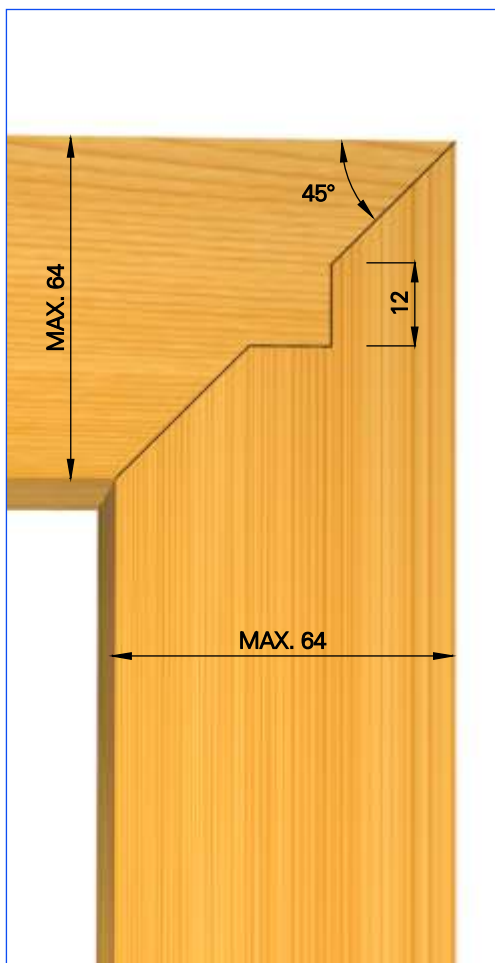

Ricambi / Spare parts / Rechanges / Repuestos / Ersatzteile

COD.	COD.	COD.	COD.	COD.	COD.
0480030014	0480050012	0480050020	0480050030	0480501000	0480501800
COD.	COD.	COD.	COD.	COD.	COD.
0480502600	048060C000	0480700612	048074A510	0480783000	048078T200

45° Mitre glue jointing cutter head set.

Juego de cabezales para ensamble de inglete 45°.

Jeu de porte - outil pour bouvetage d' angle 45°.

Messerkopfsatz zur Gehrungsverbinding 45°.